

Specifications

■ Contact Ratings

Item	Resistive load
Contact mechanism	Single crossbar
Rated load	0.3 A at 125 VAC, 1 A at 24 VDC
Carry current	1 A
Max. operating voltage	125 VAC, 60 VDC
Max. operating current	1 A
Min. permissible load - P level (See note)	1 mA at 5 VDC

Note: This value was measured at a switching frequency of 120 operations/min. This value may vary, depending on switching frequency, operating conditions, expected reliability level of the relay, etc. It is always recommended to double-check relay suitability under actual load conditions.

■ Coil Ratings

Item	Voltage Rating				
	3 VDC	4.5 VDC	5 VDC	12 VDC	24 VDC
Rated voltage	3 VDC	4.5 VDC	5 VDC	12 VDC	24 VDC
Rated current	60.0 mA	40.0 mA	36.0 mA	15.0 mA	9.6 mA
Coil resistance	50.0 Ω	112.5 Ω	139.0 Ω	800.0 Ω	2,504.0 Ω
Pick-up voltage	75% max. of rated voltage				
Dropout voltage	10% min. of rated voltage				
Maximum voltage	150% of rated voltage				130% of rated voltage
Power consumption	Approx. 180 mW				Approx. 230 mW

- Note:**
- The rated current and coil resistance are measured at a coil temperature of 23°C with a tolerance of ±10%.
 - The operating characteristics are measured at a coil temperature of 23°C.
 - The maximum voltage is the highest voltage that can be imposed on the relay coil.
 - The voltage measurements for Pick-up/Dropout are the values obtained for instantaneous changes in the voltage (rectangular wave).

■ Characteristics

Item	G6L-1P, G6L-1F	
Contact resistance (See Note 1)	100 mΩ max.	
Operate time (See Note 2)	5 ms max. (approx. 1.1 ms)	
Release time (See Note 2)	5 ms max. (approx. 0.4 ms)	
Insulation resistance (See Note 3)	1,000 MΩ min. (at 500 VDC)	
Dielectric strength	Coil and contacts	1,000 VAC, 50/60 Hz for 1 min
	Contacts of same poles	750 VAC, 50/60 Hz for 1 min
Surge withstand voltage	Coil and contacts	1,500 VAC, 10 × 160 μs
Vibration	Mechanical durability	10 to 55 Hz, 1.65-mm single amplitude (3.3-mm double amplitude)
	Malfunction durability	10 to 55 Hz, 1.65-mm single amplitude (3.3-mm double amplitude)
Shock	Mechanical durability	1,000 m/s ²
	Malfunction durability	100 m/s ²
Service life	Mechanical	5,000,000 operations min. (at 36,000 operations/hour)
	Electrical	100,000 operations min. (with a rated load at 1,800 operations/hour)
Ambient temperature	Operating: -40°C to 70°C (with no icing or condensation)	
Humidity	Operating: 5% to 85% RH	
Weight	Approx. 0.6 g	

- Note:**
- The contact resistance was measured with 10 mA at 1 VDC with a fall-of-potential method.
 - Values in parentheses are actual values.
 - The insulation resistance was measured with a 500-VDC megohmmeter applied to the same parts as those used for checking the dielectric strength.
 - The above values are initial values.

Engineering Data

Maximum Switching Capacity

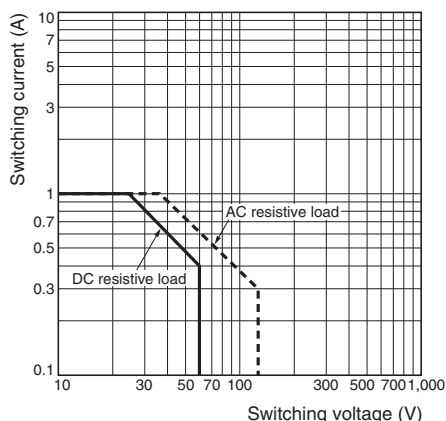

Ambient Temperature vs. Maximum Voltage

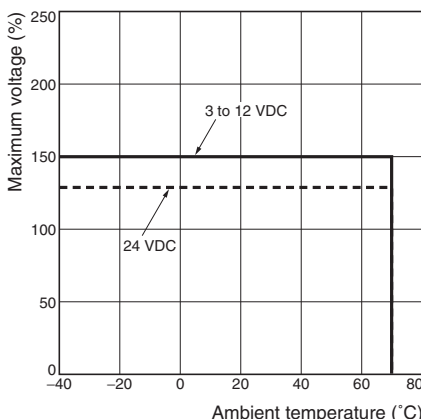

Note: "Maximum Voltage" is the maximum voltage that can be applied to the relay coil.

Ambient Temperature vs. Switching Current

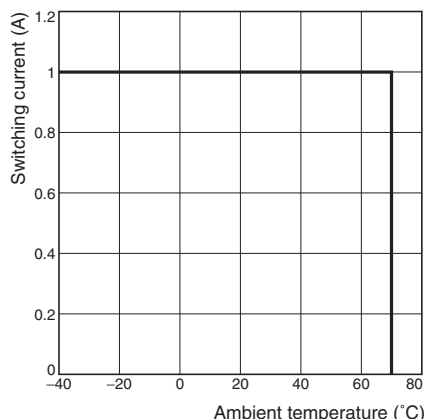

Electrical Service Life

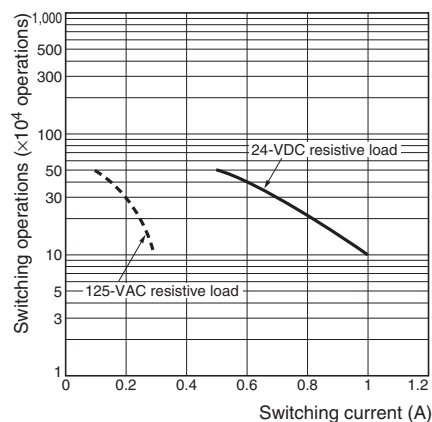

Ambient Temperature vs. Must Operate or Must Release Voltage

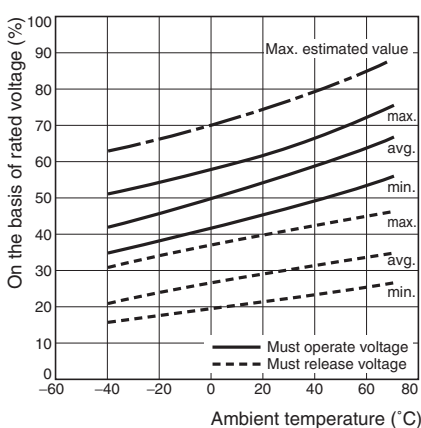

Shock Malfunction

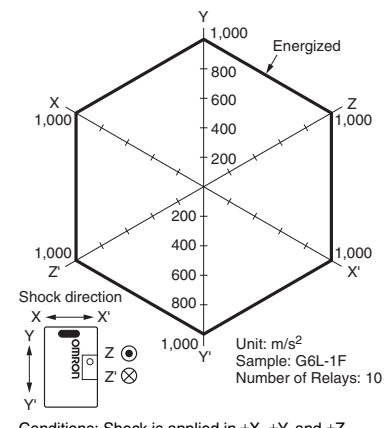

Conditions: Shock is applied in ±X, ±Y, and ±Z directions three times each with and without energizing the Relays to check the number of contact malfunctions.

Electrical Service Life (with Must Operate and Must Release Voltage) (See note 1)

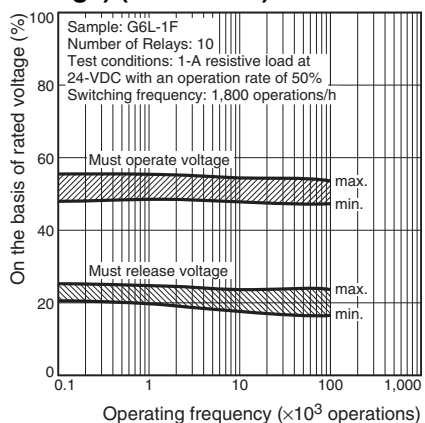

Electrical Service Life (Contact Resistance) (See note 1)

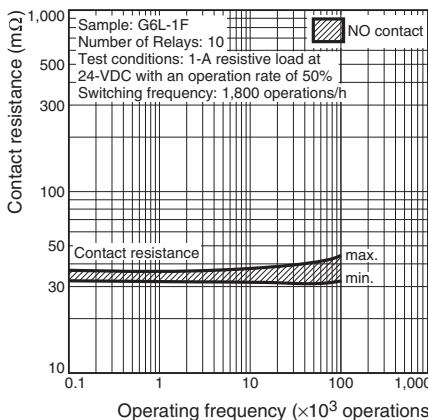

Contact Reliability Test (Contact Resistance) (See notes 1 and 2)

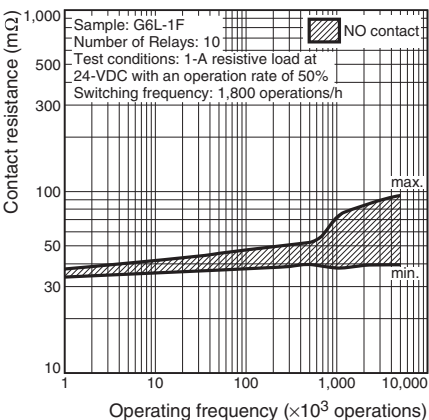

Note: 1. The tests were conducted at an ambient temperature of 23°C.
2. The contact resistance data are periodically measured reference values and are not values from each monitoring operation. Contact resistance values will vary according to the switching frequency and operating environment, so be sure to check operation under the actual operating conditions before use.

Mutual Magnetic Interference

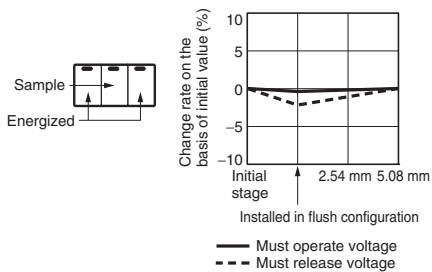

Mutual Magnetic Interference

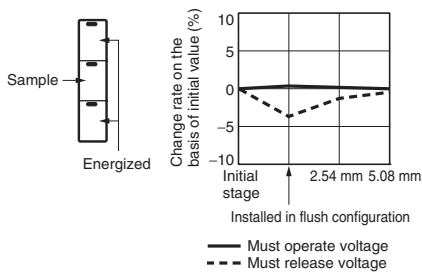

External Magnetic Interference

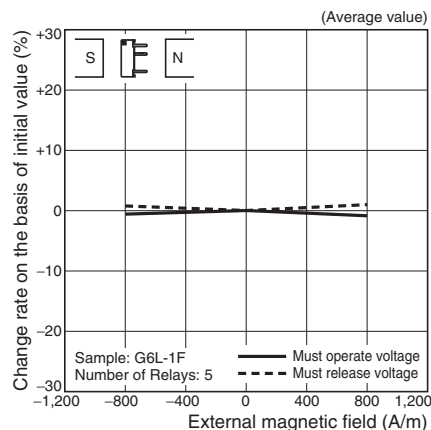
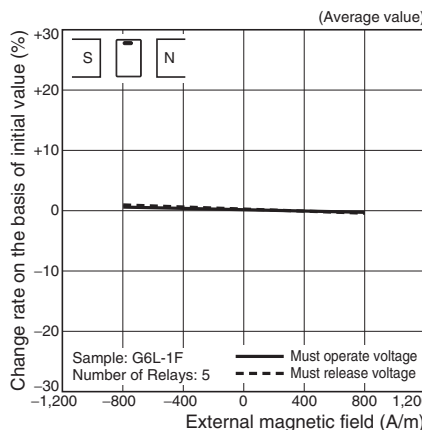
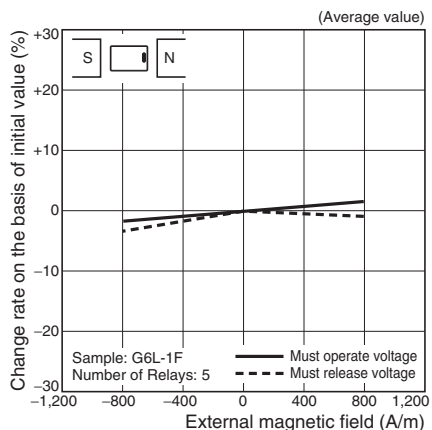

High-frequency Characteristics (Isolation) (See note)

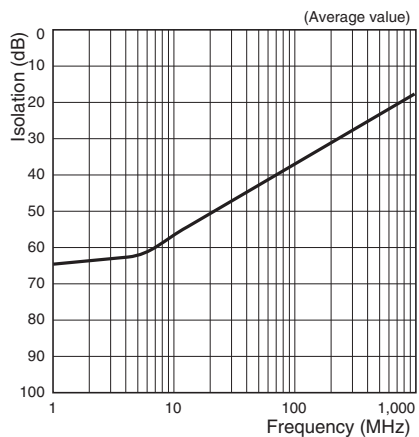

High-frequency Characteristics (Insertion Loss) (See note)

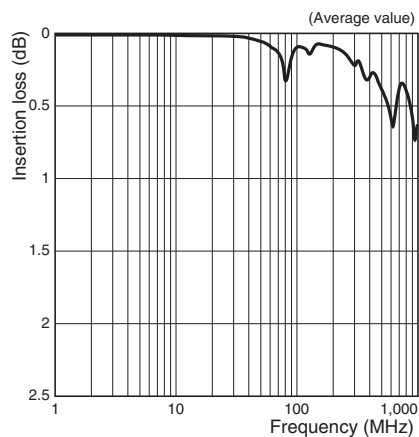

High-frequency Characteristics (Return Loss, V.SWR) (See note)

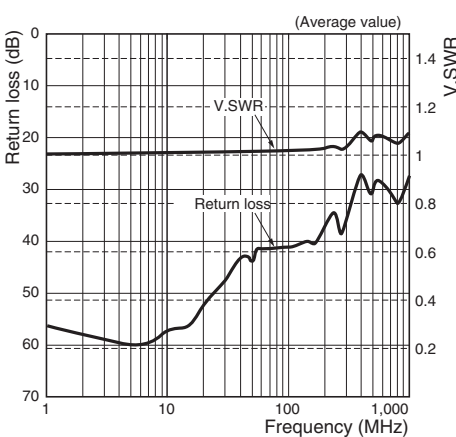

Note: High-frequency characteristics depend on the PCB to which the Relay is mounted. Always check these characteristics, including endurance, in the actual machine before use.

Must Operate and Must Release Time Distribution (See Note)

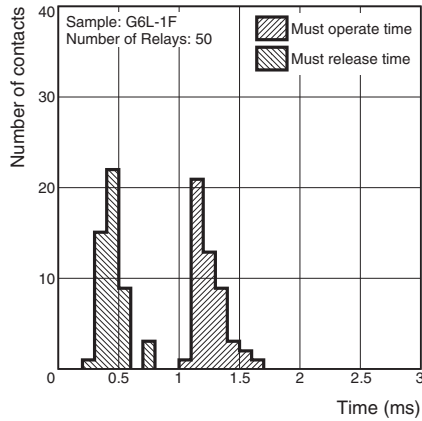

Distribution of Bounce Time (See Note)

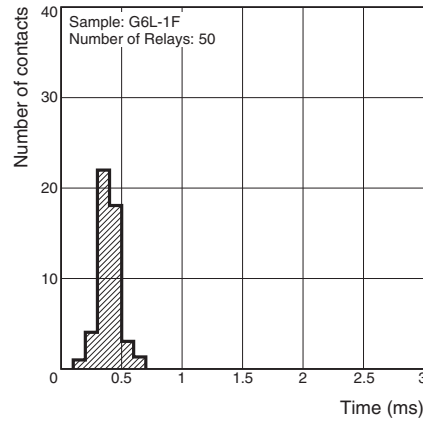

Vibration Resistance

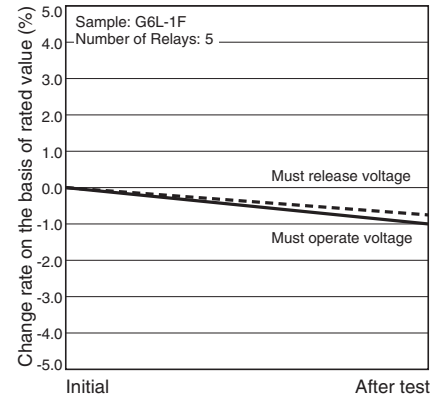

Note: The tests were conducted at an ambient temperature of 23°C.

Dimensions

Note: All units are in millimeters unless otherwise indicated.

G6L-1P

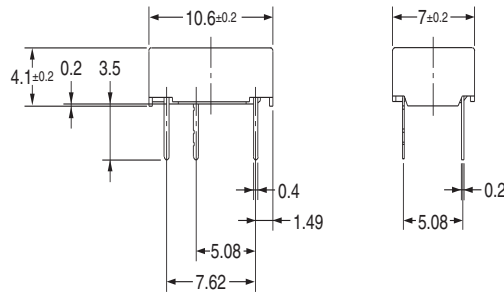
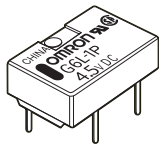

Note: Each value has a tolerance of ±0.3 mm.

PCB Mounting Holes (Bottom View)

Tolerance: ±0.1 mm

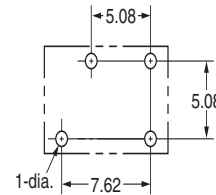

Terminal Arrangement/ Internal Connections (Bottom View)

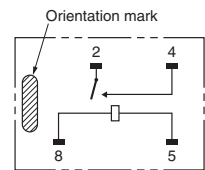

G6L-1F

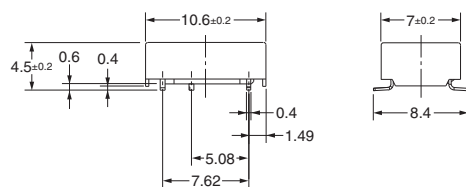
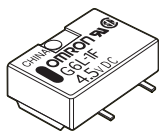

Note: Each value has a tolerance of ±0.3 mm.

PCB Mounting Holes (Top View)

Tolerance: ±0.1 mm

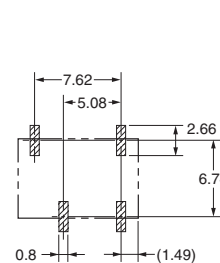

Terminal Arrangement/ Internal Connections (Top View)

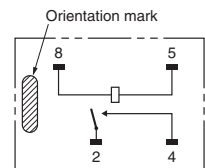

Packaging

■ Tube Packaging

Relays in tube packaging are arranged so that the orientation mark of each Relay is on the left side.

Always confirm that the Relays are in the correct orientation when mounting the Relays to the PCBs.

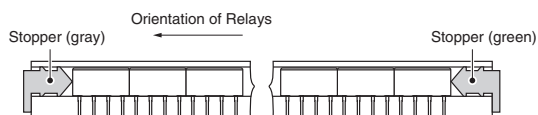

Tube length: 552 mm (stopper not included)
No. of Relays per tube: 50

■ Tape and Reel Packaging (Surface-mount models)

When ordering Relays in tape and reel packaging, add the suffix “-TR” to the model number, otherwise the Relays in tube packaging will be provided.

- Tape type: TB2412R (Refer to EIAJ (Electronic Industries Association of Japan))
- Reel type: R24D (Refer to EIAJ (Electronic Industries Association of Japan))
- Relays per reel: 1,000

1. Direction of Relay Insertion

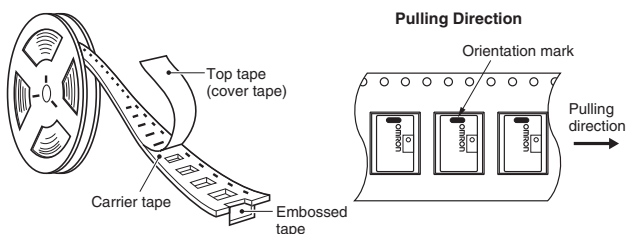

2. Reel Dimensions

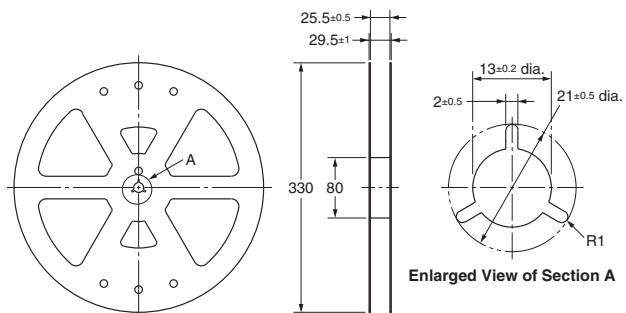

3. Carrier Tape Dimensions

G6L-1F

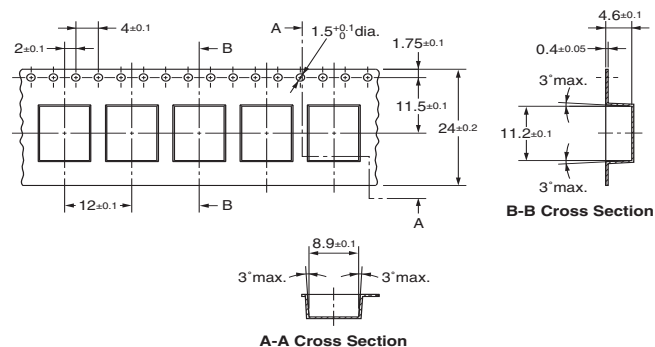

Recommended Soldering Method

Temperature Profile According to IRS

When performing reflow-soldering, check the profile on an actual device after setting the temperature condition so that the temperatures at the relay terminals and the upper surface of the case do not exceed the limits specified in the following tables.

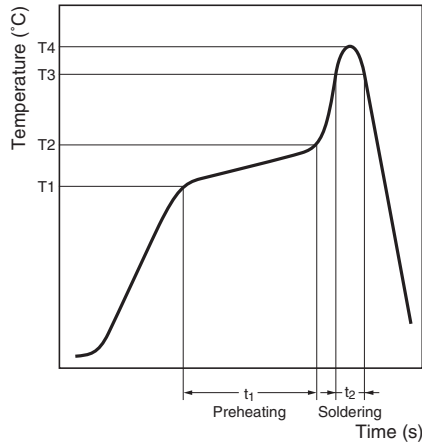

The thickness of cream solder to be applied should be within a range between 150 and 200 μm on OMRON's recommended PCB pattern.

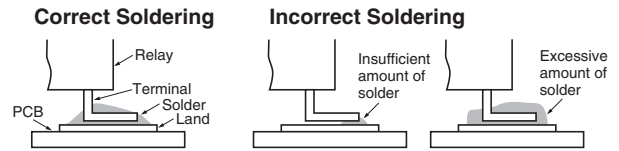

Visually check that the Relay is properly soldered.

Item	Preheating (T1 to T2, t ₁)	Soldering (T3, t ₂)	Peak value (T4)
Measuring position			
Terminal	150°C to 180°C, 120 s max.	180°C to 200°C, 20 to 30 s	245°C max.
Upper surface of case	—	—	250°C max.

Item	Preheating (T1 to T2, t ₁)	Soldering (T3, t ₂)	Peak value (T4)
Measuring position			
Terminal	150°C to 180°C, 120 s max.	230°C, 30 s max.	250°C max.
Upper surface of case	—	—	255°C max.

Approved Standards

UL Recognized (File No. E41515) / CSA Certified (File No. LR31928) - - Ambient Temp. = 40°C

Contact form	Coil rating	Contact rating	Number of test operations
SPST-NO	G6L-1P and G6L-1F: 3 to 24 VDC	1A at 30 VDC (Resistive) 0.5A at 60 VDC (Resistive) 0.3A at 125 VAC (General Use)	6,000

Precautions

■ Correct Use

Long-term Continuously ON Contacts

Using the Relay in a circuit where the Relay will be ON continuously for long periods (without switching) can lead to unstable contacts because the heat generated by the coil itself will affect the insulation, causing a film to develop on the contact surfaces. Be sure to use a fail-safe circuit design that provides protection against contact failure or coil burnout.

Handling

Leave the Relays packed until just prior to mounting them.

Soldering

Solder: JIS Z3282, H63A

Soldering temperature: Approx. 250°C (At 260°C if the DWS method is used.)

Soldering time: Approx. 5 s max. (approx. 2 s for the first time and approx. 3 s for the second time if the DWS method is used.)

Be sure to adjust the level of the molten solder so that the solder will not overflow onto the PCB.

Claw Securing Force During Automatic Insertion

During automatic insertion of Relays, make sure to set the securing force of the claws to the following values so that the Relay characteristics will be maintained.

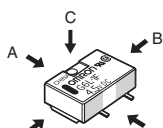

Direction A: 5.0 N max.

Direction B: 5.0 N max.

Direction C: 5.0 N max.

Secure the claws to the area indicated by shading.

Do not attach them to the center area or to only part of the Relay.

Environmental Conditions During Operation, Storage, and Transportation

Protect the Relays from direct sunlight and keep the Relays under normal temperature, humidity, and pressure.

Maximum Voltage

The maximum voltage of the coil can be obtained from the coil temperature increase and the heat-resisting temperature of coil insulating sheath material. (Exceeding the heat-resisting temperature may result in burning or short-circuiting). The maximum voltage also involves important restrictions which include the following:

- Must not cause thermal changes in or deterioration of the insulating material.
- Must not cause damage to other control devices.
- Must not cause any harmful effect on people.
- Must not cause fire.

Therefore, be sure not to exceed the maximum voltage specified in the catalog.

As a rule, the rated voltage must be applied to the coil. A voltage exceeding the rated value, however, can be applied to the coil provided that the voltage is less than the maximum voltage. It must be noted that continuous voltage application to the coil will cause a coil temperature increase thus affecting characteristics such as electrical life and resulting in the deterioration of coil insulation.

Coating

Relays mounted on PCBs may be coated or washed. Do not apply silicone coating or detergent containing silicone, otherwise the silicone coating or detergent may remain on the surface of the Relays.

Coil Power Supply Waveform

If the voltage applied to the coil is increased or decreased gradually, operating characteristics may be unstable, contact endurance may decline, or the Relay may not function at its full performance level. Therefore, always use an instantaneous ON and instantaneous OFF when applying the voltage. Be sure that the rated voltage or zero voltage is reached within 1 ms.

Omron Electronic Components, LLC

Terms and Conditions of Sales

I. GENERAL

- Definitions:** The words used herein are defined as follows.
 - Terms:** These terms and conditions
 - Seller:** Omron Electronic Components LLC and its subsidiaries
 - Buyer:** The buyer of Products, including any end user in section III through VI
 - Products:** Products and/or services of Seller
 - Including:** Including without limitation
- Offer/Acceptance:** These Terms are deemed part of all quotations, acknowledgments, invoices, purchase orders and other documents, whether electronic or in writing, relating to the sale of Products by Seller. Seller hereby objects to any Terms proposed in Buyer's purchase order or other documents which are inconsistent with, or in addition to, these Terms.
- Distributor:** Any distributor shall inform its customer of the contents after and including section III of these Terms.

II. SALES

- Prices/Payment:** All prices stated are current, subject to change without notice by Seller. Buyer agrees to pay the price in effect at the time the purchase order is accepted by Seller. Payments for Products received are due net 30 days unless otherwise stated in the invoice. Buyer shall have no right to set off any amounts against the amount owing in respect of this invoice.
- Discounts:** Cash discounts, if any, will apply only on the net amount of invoices sent to Buyer after deducting transportation charges, taxes and duties, and will be allowed only if (a) the invoice is paid according to Seller's payment terms and (b) Buyer has no past due amounts owing to Seller.
- Interest:** Seller, at its option, may charge Buyer 1.5% interest per month or the maximum legal rate, whichever is less, on any balance not paid within the stated terms.
- Orders:** Seller will accept no order less than 200 U.S. dollars net billing.
- Currencies:** If the prices quoted herein are in a currency other than U.S. dollars, Buyer shall make remittance to Seller at the then current exchange rate most favorable to Seller; provided that if remittance is not made when due, Buyer will convert the amount to U.S. dollars at the then current exchange rate most favorable to Seller available during the period between the due date and the date remittance is actually made.
- Governmental Approvals:** Buyer shall be responsible for all costs involved in obtaining any government approvals regarding the importation or sale of the Products.
- Taxes:** All taxes, duties and other governmental charges (other than general real property and income taxes), including any interest or penalties thereon, imposed directly or indirectly on Seller or required to be collected directly or indirectly by Seller for the manufacture, production, sale, delivery, importation, consumption or use of the Products sold hereunder (including customs duties and sales, excise, use, turnover and license taxes) shall be charged to and remitted by Buyer to Seller.
- Financial:** If the financial position of Buyer at any time becomes unsatisfactory to Seller, Seller reserves the right to stop shipments or require satisfactory security or payment in advance. If Buyer fails to make payment or otherwise comply with these Terms or any related agreement, Seller may (without liability and in addition to other remedies) cancel any unshipped portion of Products sold hereunder and stop any Products in transit until Buyer pays all amounts, including amounts payable hereunder, whether or not then due, which are owing to it by Buyer. Buyer shall in any event remain liable for all unpaid accounts.
- Cancellation; Etc:** Orders are not subject to rescheduling or cancellation unless Buyer indemnifies Seller fully against all costs or expenses arising in connection therewith.
- Force Majeure:** Seller shall not be liable for any delay or failure in delivery resulting from causes beyond its control, including earthquakes, fires, floods, strikes or other labor disputes, shortage of labor or materials, accidents to machinery, acts of sabotage, riots, delay in or lack of transportation or the requirements of any government authority.
- Shipping; Delivery:** Unless otherwise expressly agreed in writing by Seller:
 - All sales and shipments of Products shall be FOB shipping point (unless otherwise stated in writing by Seller), at which point title to and all risk of loss of the Products shall pass from Seller to Buyer, provided that Seller shall retain a security interest in the Products until the full purchase price is paid by Buyer;
 - Delivery and shipping dates are estimates only; and
 - Seller will package Products as it deems proper for protection against normal handling and extra charges apply to special conditions.
- Claims:** Any claim by Buyer against Seller for shortage or damage to the Products occurring before delivery to the carrier or any claim related to pricing or other charges must be presented in detail in writing to Seller within 30 days of receipt of shipment.

III. PRECAUTIONS

- Suitability:** IT IS THE BUYER'S SOLE RESPONSIBILITY TO ENSURE THAT ANY OMRON PRODUCT IS FIT AND SUFFICIENT FOR USE IN A MOTORIZED VEHICLE APPLICATION. BUYER SHALL BE SOLELY RESPONSIBLE FOR DETERMINING APPROPRIATENESS OF THE PARTICULAR PRODUCT WITH RESPECT TO THE BUYER'S APPLICATION INCLUDING (A) ELECTRICAL OR ELECTRONIC COMPONENTS, (B) CIRCUITS, (C) SYSTEM ASSEMBLIES, (D) END PRODUCT, (E) SYSTEM, (F) MATERIALS OR SUBSTANCES OR (G) OPERATING ENVIRONMENT. Buyer acknowledges that it alone has determined that the Products will meet their requirements of the intended use in all cases. Buyer must know and observe all prohibitions of use applicable to the Product/s.
- Use with Attention:** The followings are some examples of applications for which particular attention must be given. This is not intended to be an exhaustive list of all possible use of any Product, nor to imply that any use listed may be suitable for any Product:
 - Outdoor use, use involving potential chemical contamination or electrical interference.

- Use in consumer Products or any use in significant quantities.
 - Energy control systems, combustion systems, railroad systems, aviation systems, medical equipment, amusement machines, vehicles, safety equipment, and installations subject to separate industry or government regulations.
 - Systems, machines, and equipment that could present a risk to life or property.
- Prohibited Use:** NEVER USE THE PRODUCT FOR AN APPLICATION INVOLVING SERIOUS RISK TO LIFE OR PROPERTY WITHOUT ENSURING THAT THE SYSTEM AS A WHOLE HAS BEEN DESIGNED TO ADDRESS THE RISKS, AND THAT THE PRODUCT IS PROPERLY RATED AND INSTALLED FOR THE INTENDED USE WITHIN THE OVERALL EQUIPMENT OR SYSTEM.
 - Motorized Vehicle Application:** USE OF ANY PRODUCT/S FOR A MOTORIZED VEHICLE APPLICATION MUST BE EXPRESSLY STATED IN THE SPECIFICATION BY SELLER.
 - Programmable Products:** Seller shall not be responsible for the Buyer's programming of a programmable Product.

IV. WARRANTY AND LIMITATION

- Warranty:** Seller's exclusive warranty is that the Products will be free from defects in materials and workmanship for a period of twelve months from the date of sale by Seller (or such other period expressed in writing by Seller). SELLER MAKES NO WARRANTY OR REPRESENTATION, EXPRESS OR IMPLIED, ABOUT ALL OTHER WARRANTIES, NON-INFRINGEMENT, MERCHANTABILITY OR FITNESS FOR A PARTICULAR PURPOSE OF THE PRODUCTS.
- Buyer Remedy:** Seller's sole obligation hereunder shall be to replace (in the form originally shipped with Buyer responsible for labor charges for removal or replacement thereof) the non-complying Product or, at Seller's election, to repay or credit Buyer an amount equal to the purchase price of the Product; provided that there shall be no liability for Seller or its affiliates unless Seller's analysis confirms that the Products were correctly handled, stored, installed and maintained and not subject to contamination, abuse, misuse or inappropriate modification. Return of any Products by Buyer must be approved in writing by Seller before shipment.
- Limitation on Liability:** SELLER AND ITS AFFILIATES SHALL NOT BE LIABLE FOR SPECIAL, INDIRECT, INCIDENTAL OR CONSEQUENTIAL DAMAGES, LOSS OF PROFITS OR PRODUCTION OR COMMERCIAL LOSS IN ANY WAY CONNECTED WITH THE PRODUCTS, WHETHER SUCH CLAIM IS BASED IN CONTRACT, WARRANTY, NEGLIGENCE OR STRICT LIABILITY. FURTHER, IN NO EVENT SHALL LIABILITY OF SELLER OR ITS AFFILIATES EXCEED THE INDIVIDUAL PRICE OF THE PRODUCT ON WHICH LIABILITY IS ASSERTED.
- Indemnities:** Buyer shall indemnify and hold harmless Seller, its affiliates and its employees from and against all liabilities, losses, claims, costs and expenses (including attorney's fees and expenses) related to any claim, investigation, litigation or proceeding (whether or not Seller is a party) which arises or is alleged to arise from Buyer's acts or omissions under these Terms or in any way with respect to the Products.

V. INFORMATION; ETC.

- Intellectual Property:** The intellectual property embodied in the Products is the exclusive property of Seller and its affiliates and Buyer shall not attempt to duplicate it in any way without the written permission of Seller. Buyer (at its own expense) shall indemnify and hold harmless Seller and defend or settle any action brought against Seller to the extent that it is based on a claim that any Product made to Buyer specifications infringed intellectual property rights of another party.
- Property; Confidentiality:** Notwithstanding any charges to Buyer for engineering or tooling, all engineering and tooling shall remain the exclusive property of Seller. All information and materials supplied by Seller to Buyer relating to the Products are confidential and proprietary, and Buyer shall limit distribution thereof to its trusted employees and strictly prevent disclosure to any third party.
- Performance Data:** Performance data is provided as a guide in determining suitability and does not constitute a warranty. It may represent the result of Seller's test conditions, and the users must correlate it to actual application requirements.
- Change In Specifications:** Product specifications and descriptions may be changed at any time based on improvements or other reasons. It is Seller's practice to change part numbers when published ratings or features are changed, or when significant engineering changes are made. However, some specifications of the Product may be changed without any notice.
- Errors And Omissions:** The information on Seller's website or in other documentation has been carefully checked and is believed to be accurate; however, no responsibility is assumed for clerical, typographical or proofreading errors or omissions.
- Export Controls:** Buyer shall comply with all applicable laws, regulations and licenses regarding (a) export of the Products or information provided by Seller; (b) sale of Products to forbidden or other proscribed persons or organizations; (c) disclosure to non-citizens of regulated technology or information.

VI. MISCELLANEOUS

- Waiver:** No failure or delay by Seller in exercising any right and no course of dealing between Buyer and Seller shall operate as a waiver of rights by Seller.
- Assignment:** Buyer may not assign its rights hereunder without Seller's written consent.
- Law:** These Terms are governed by Illinois law (without regard to conflict of laws). Federal and state courts in Cook County, Illinois have exclusive jurisdiction for any dispute hereunder.
- Amendment:** These Terms constitute the entire agreement between Buyer and Seller relating to the Products, and no provision may be changed or waived unless in writing signed by the parties.
- Severability:** If any provision hereof is rendered ineffective or invalid, such provision shall not invalidate any other provision.

Certain Precautions on Specifications and Use

1. **Suitability for Use.** Seller shall not be responsible for conformity with any standards, codes or regulations which apply to the combination of the Product in Buyer's application or use of the Product. At Buyer's request, Seller will provide applicable third party certification documents identifying ratings and limitations of use which apply to the Product. This information by itself is not sufficient for a complete determination of the suitability of the Product in combination with the end product, machine, system, or other application or use. Buyer shall be solely responsible for determining appropriateness of the particular Product with respect to Buyer's application, product or system. Buyer shall take application responsibility in all cases but the following is a non-exhaustive list of applications for which particular attention must be given:
 - (i) Outdoor use, uses involving potential chemical contamination or electrical interference, or conditions or uses not described in this document.
 - (ii) Energy control systems, combustion systems, railroad systems, aviation systems, medical equipment, amusement machines, vehicles, safety equipment, and installations subject to separate industry or government regulations.
 - (iii) Use in consumer products or any use in significant quantities.
 - (iv) Systems, machines and equipment that could present a risk to life or property. Please know and observe all prohibitions of use applicable to this product.

NEVER USE THE PRODUCT FOR AN APPLICATION INVOLVING SERIOUS RISK TO LIFE OR PROPERTY WITHOUT ENSURING THAT THE SYSTEM AS A WHOLE HAS BEEN DESIGNED TO ADDRESS THE RISKS, AND THAT THE OMRON PRODUCT IS PROPERLY RATED AND INSTALLED FOR THE INTENDED USE WITHIN THE OVERALL EQUIPMENT OR SYSTEM.
2. **Programmable Products.** Seller shall not be responsible for the user's programming of a programmable product, or any consequence thereof.
3. **Performance Data.** Performance data given in this publication is provided as a guide for the user in determining suitability and does not constitute a warranty. It may represent the result of Seller's test conditions, and the users must correlate it to actual application requirements. Actual performance is subject to Seller's Warranty and Limitations of Liability.
4. **Change in Specifications.** Product specifications and accessories may be changed at any time based on improvements and other reasons. It is our practice to change part numbers when published ratings or features are changed, or when significant construction changes are made. However, some specifications of the Product may be changed without any notice. When in doubt, special part numbers may be assigned to fix or establish key specifications for your application. Please consult with your Seller representative at any time to confirm actual specifications of purchased Product.
5. **Errors and Omissions.** The information in this publication has been carefully checked and is believed to be accurate; however, no responsibility is assumed for clerical, typographical or proofreading errors, or omissions.
6. **RoHS Compliance.** Where indicated, our products currently comply, to the best of our knowledge as of the date of this publication, with the requirements of the European Union's Directive on the Restriction of certain Hazardous Substances ("RoHS"), although the requirements of RoHS do not take effect until July 2006. These requirements may be subject to change. Please consult our website for current information.

Complete "Terms and Conditions of Sale" for product purchase and use are on Omron's website at <http://www.components.omron.com> – under the "About Us" tab, in the Legal Matters section.

ALL DIMENSIONS SHOWN ARE IN MILLIMETERS.

To convert millimeters into inches, multiply by 0.03937. To convert grams into ounces, multiply by 0.03527.

OMRON[®]**OMRON ELECTRONIC COMPONENTS LLC**55 E. Commerce Drive, Suite B
Schaumburg, IL 60173**847-882-2288****OMRON ON-LINE**Global - <http://www.omron.com>USA - <http://www.components.omron.com>

Cat. No. X301-E-1

06/09

Specifications subject to change without notice

Printed in USA